

# 电磁式/磁电式转速传感器 形状分类表

MP-900/9000 系列 (电磁式)

不需要电源

MP-981/AP-981 (磁电式)

中低速/防酸防浸型

- A 测量频率范围
- B 检测齿轮模数

MP-992 **A 400~100,000 (Hz)**  
**B 1~3** **小型**

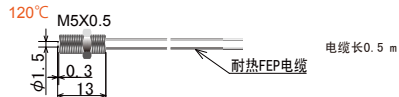

MP-950 **A 300~35,000 (Hz)**  
**B 1~3**

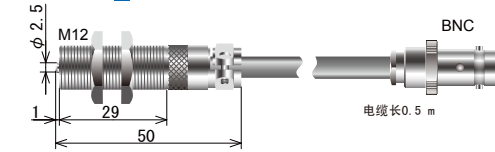

MP-962 **A 400~35,000 (Hz)**  
**B 1~3**

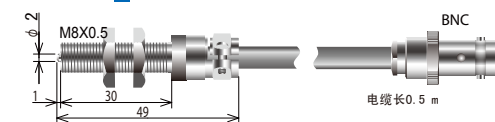

## 安装示意图

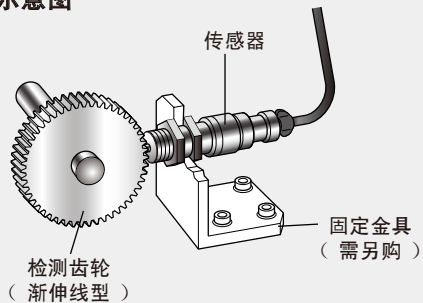

MP-936

**耐热**  
220°C

**A 300~35,000 (Hz)**  
**B 1~3**

**防护型**

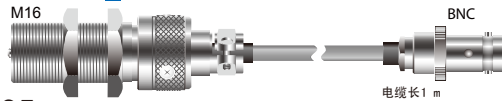

MP-935

**1) 防油/耐热**  
150°C

**A 300~35,000 (Hz)**  
**B 1~3**

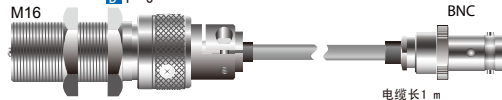

MP-930

**1) 防油**

**A 200~35,000 (Hz)**  
**B 1~3**

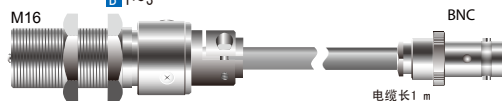

1) 符合日本电机工业标准JEM-1030-1983, 防油

(通用型) MP-9100 **A 200~35,000 (Hz)**  
**B 1~3** **通用型**

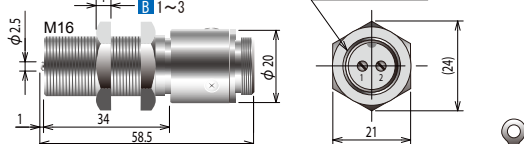

MP-911

**A 200~35,000 (Hz)**  
**B 1~3**

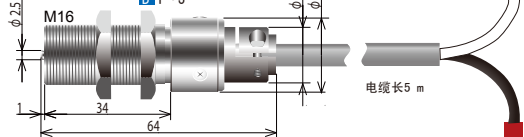

MP-9200

**A 300~35,000 (Hz)**  
**B 0.5~1**

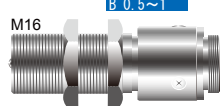

**小模数**

MP-963

**A 45~15,000 (Hz)**  
**B 3~10**

**中模数**

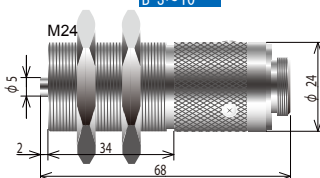

MP-9120

**A 200~80,000 (Hz)**  
**B 1~3**

**高速用**

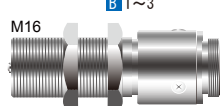

MP-981

**磁电式 超低速/中速**

**A 1~20,000 (Hz)**  
**B 0.5~3**

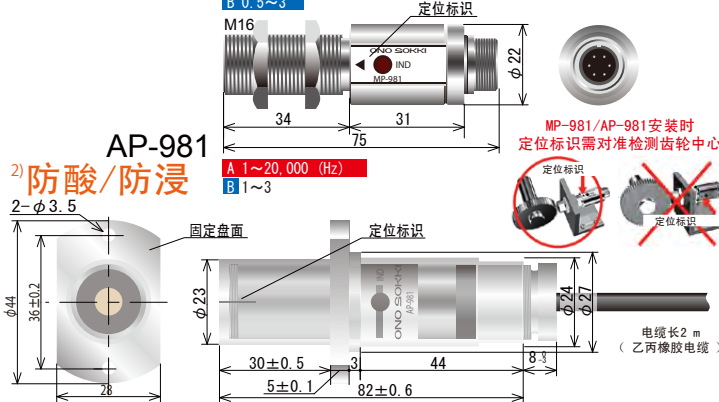

AP-981

**A 1~20,000 (Hz)**  
**B 1~3**

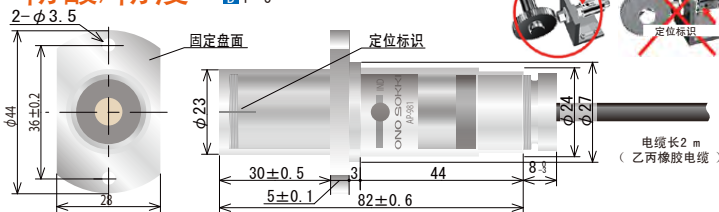

2) 符合JIS C0920 防水试验的防护等级 IPX7 防浸

MP-940A

**A 300~35,000 (Hz)**  
**B 1~3**

**长型**

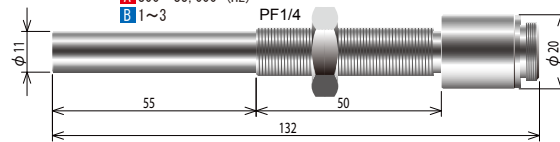

MP-954

**A 300~35,000 (Hz)**  
**B 1~3**

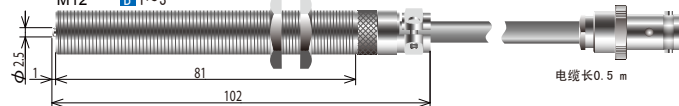

MP-001

MP系列用标准检测齿轮

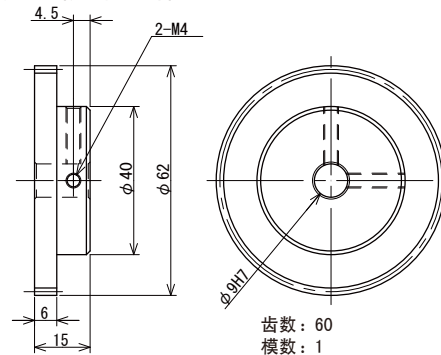

齿数: 60  
模数: 1  
材质: SS400 (带电镀)